

OUTBACK[®]

PLUNGE POOL

Plumbing Diagram

To be used in conjunction with site specific permit documentation, OUTBACK Engineering and any other OUTBACK Installation Guides.

- 1. Hole Positions**
- 2. Without Spa Jets**
- 3. With Spa Jets**



1. Hole Positions

Standard Holes

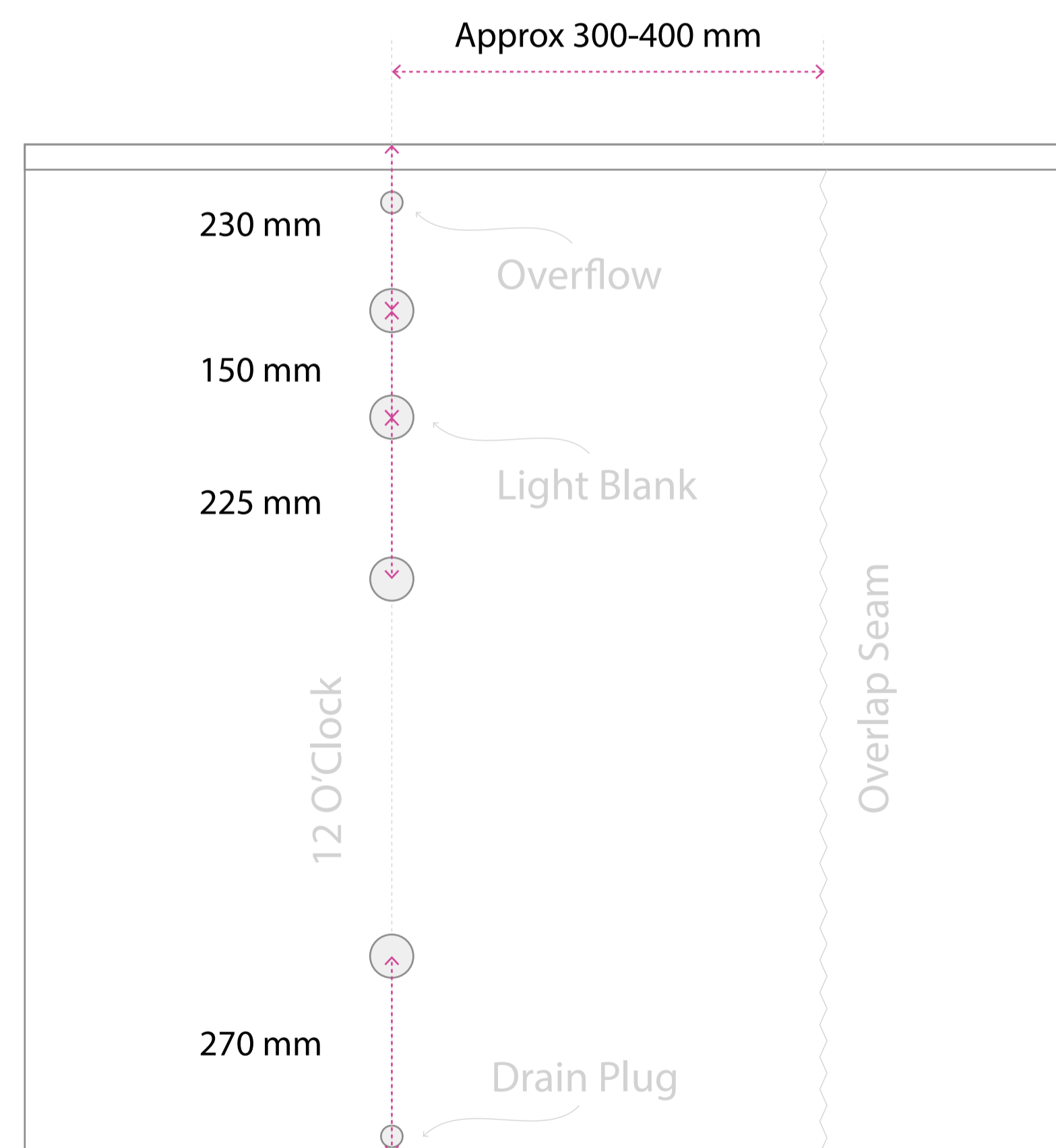

Spa Jets Single Set

X = Customer Request

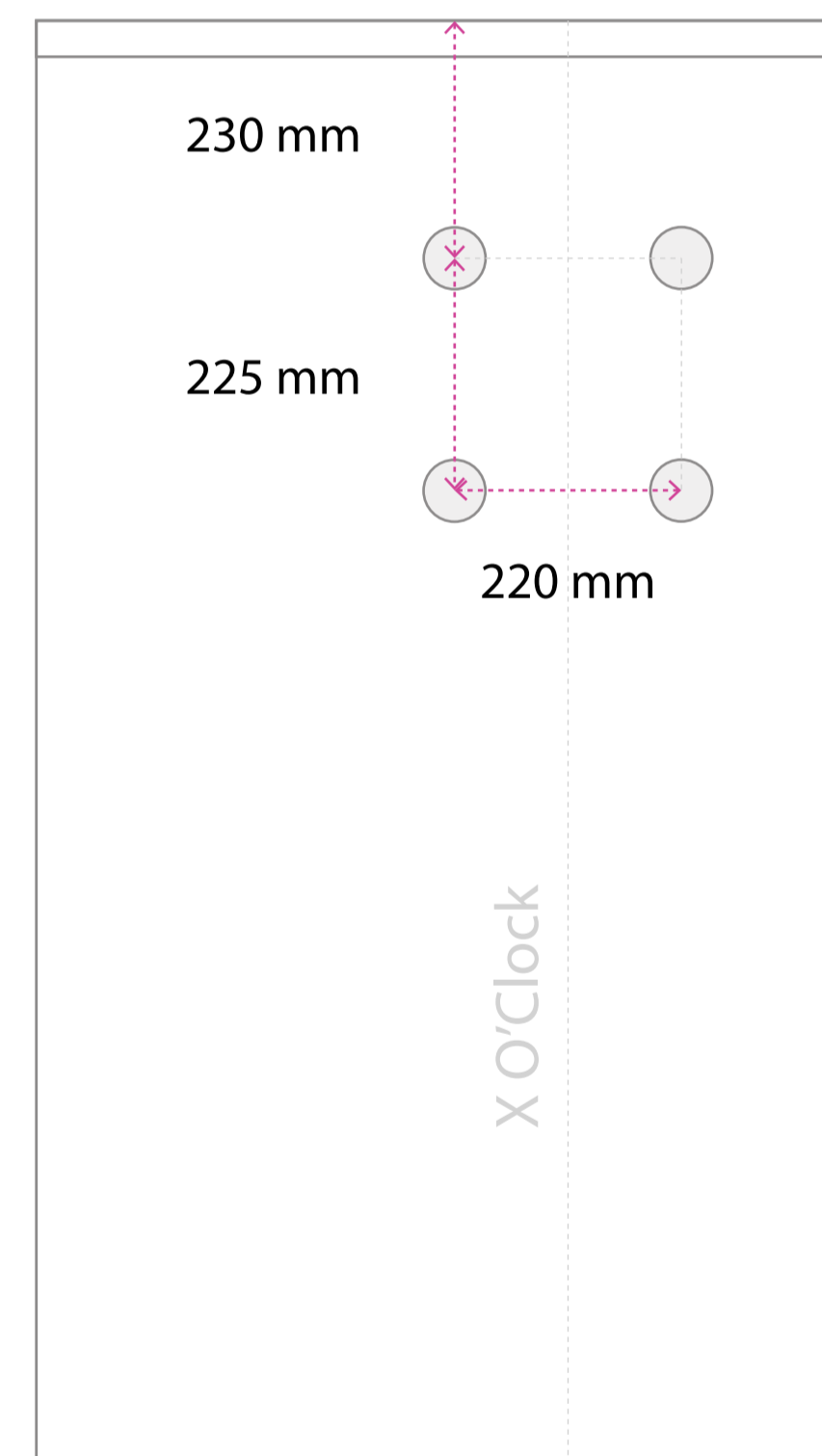

Spa Jets Double Set

X = Customer Request

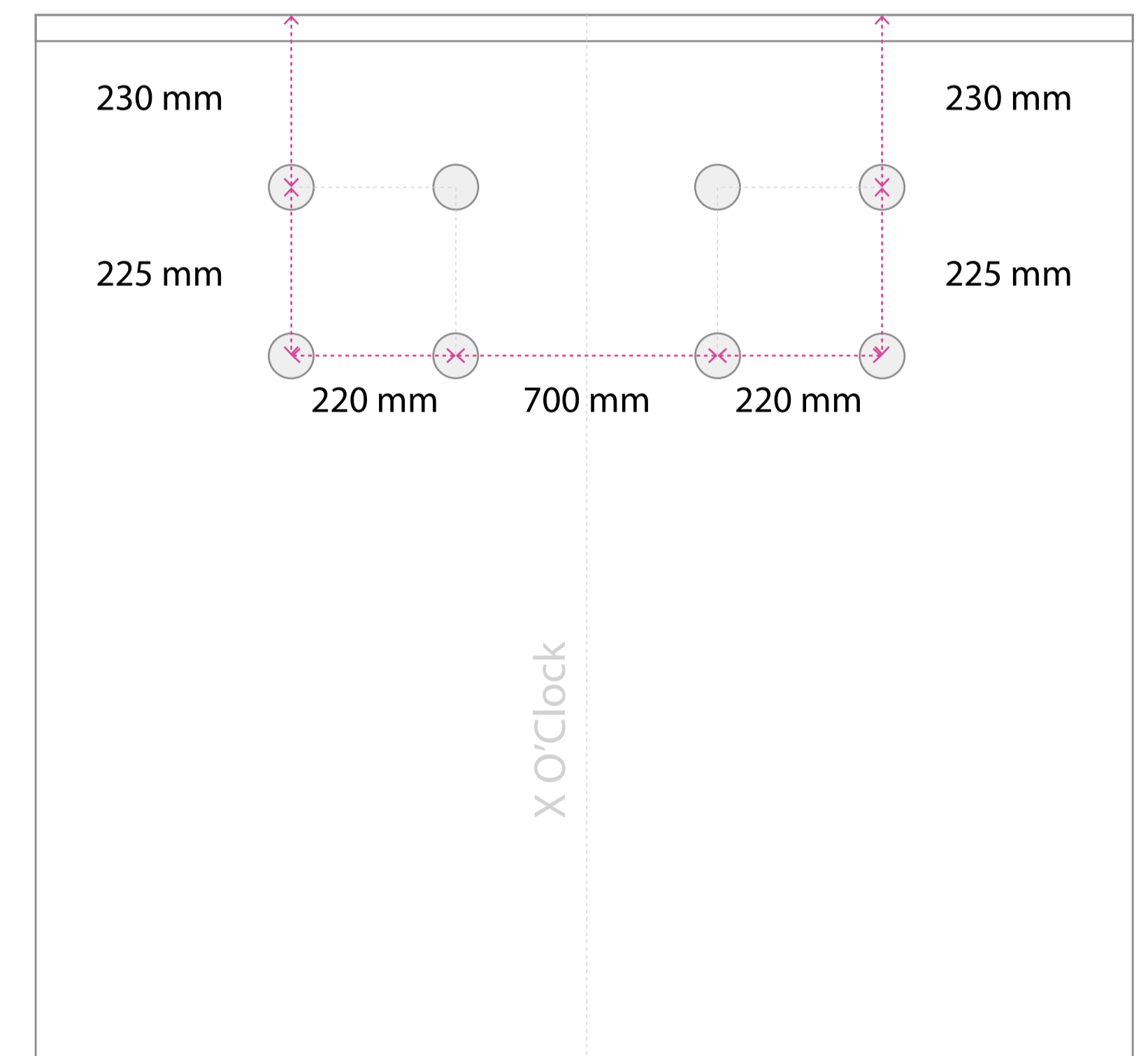

Outside Pool View

2. Without Spa Jets

 **OUTBACK Provides**

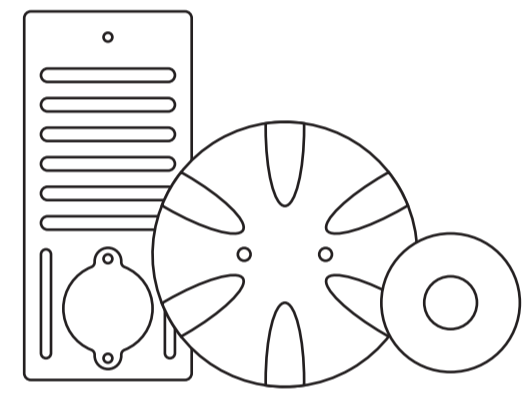

x1 Skimmer,
Suction & Eyeball

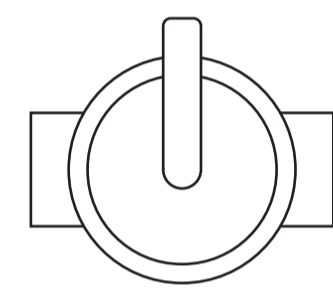

x2 40mm
2-Way Valves

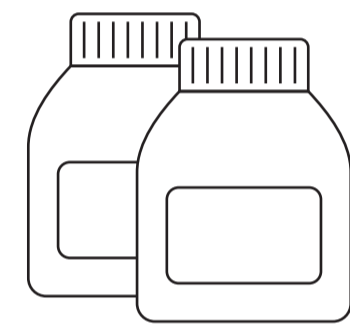

Primer &
Pressure Glue

 **Customer or Engaged Contractor Provides**



40mm Pressure Pipe
(Class 9 or 12)

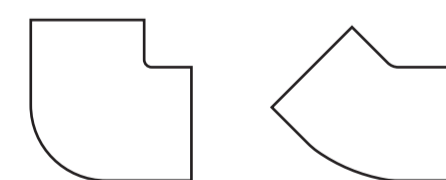

Various 40mm
45 & 90 Degree Elbows
(Class 9 or 12)

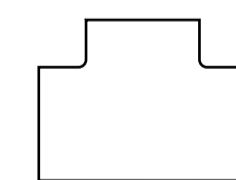

x1 40mm T Coupling
(Class 9 or 12)

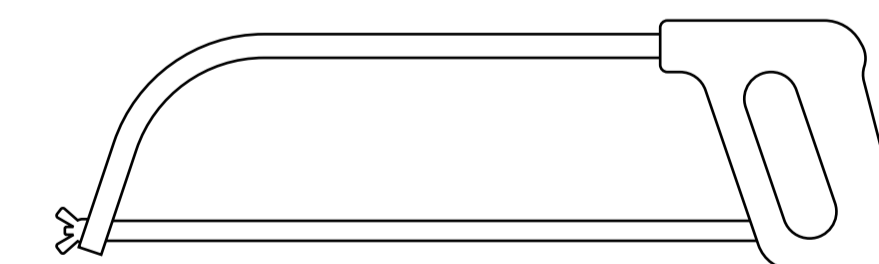

Hacksaw or similar

40mm Pipe & Fittings

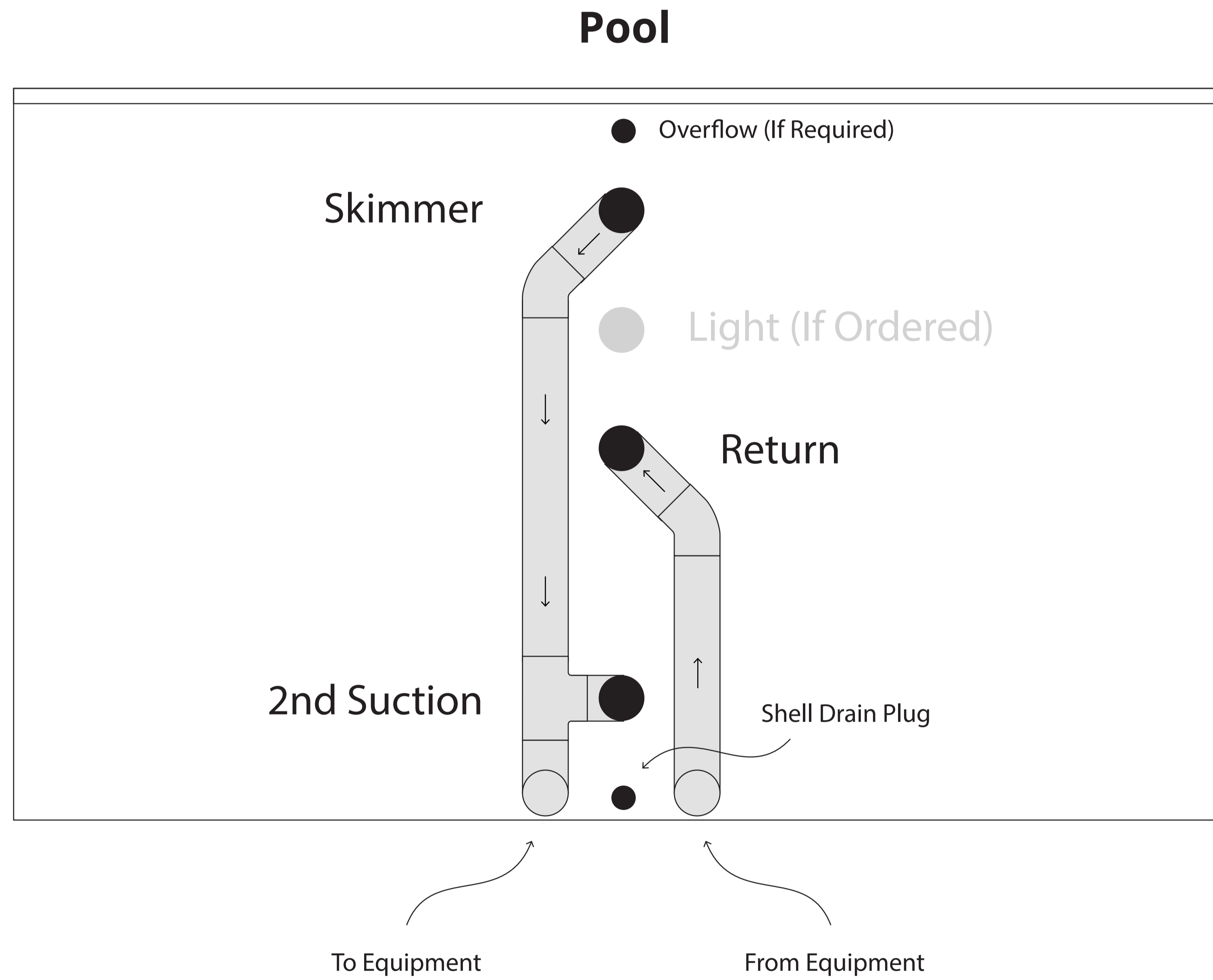

FRONT VIEW

40mm Pipe & Fittings

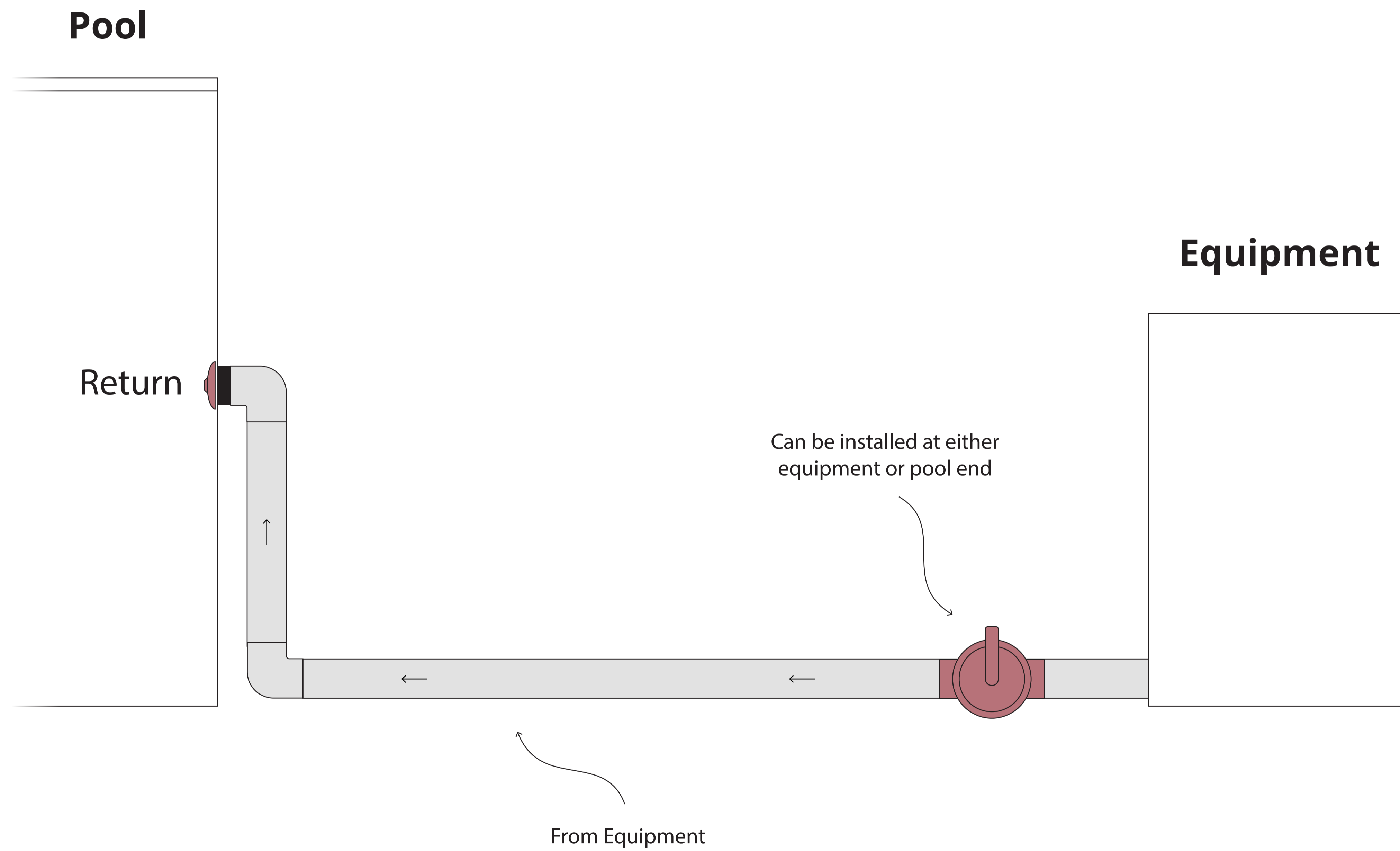

SIDE VIEW (Return)

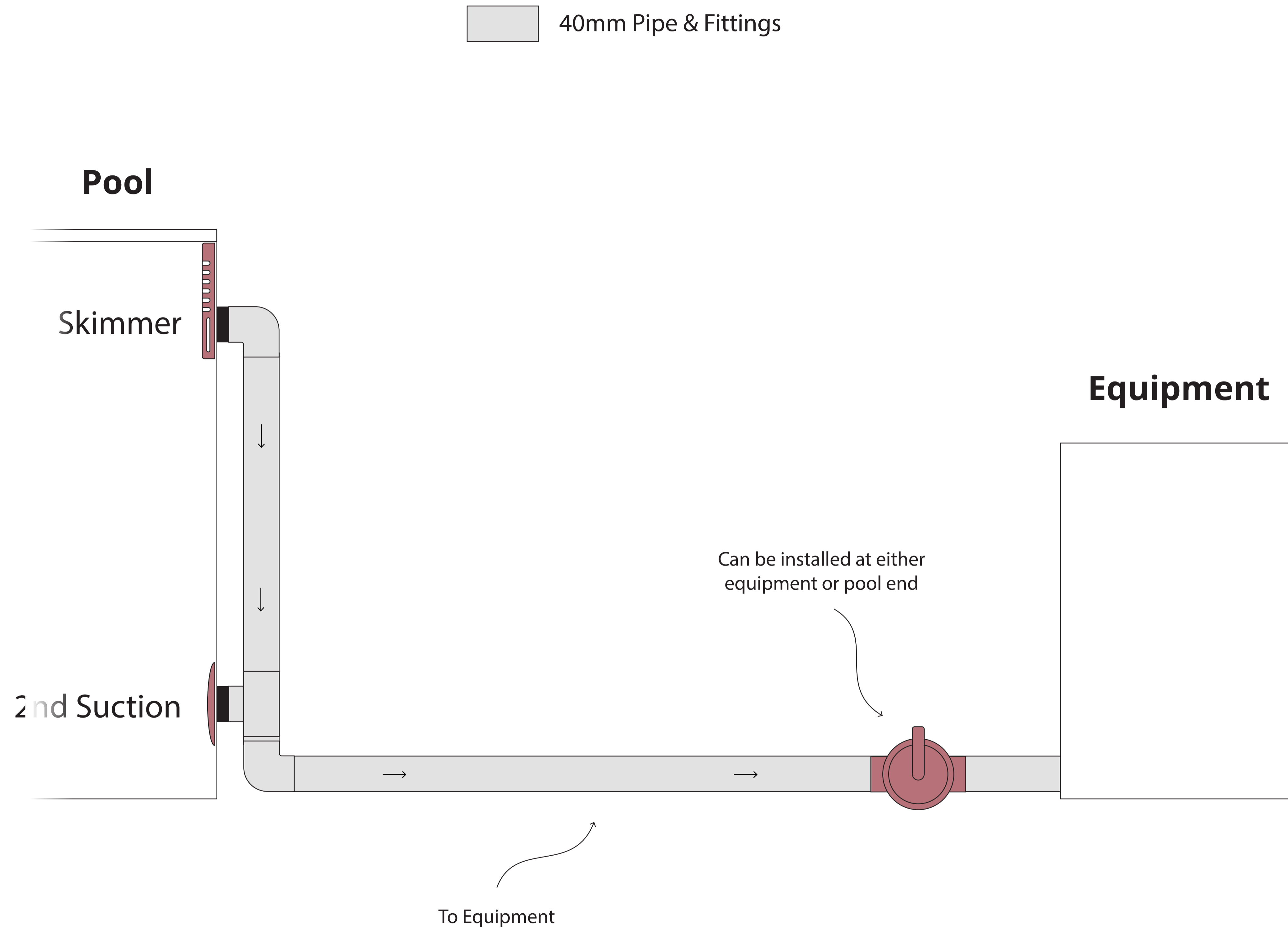

SIDE VIEW (Suctions)

3. With Spa Jets

OUTBACK Provides

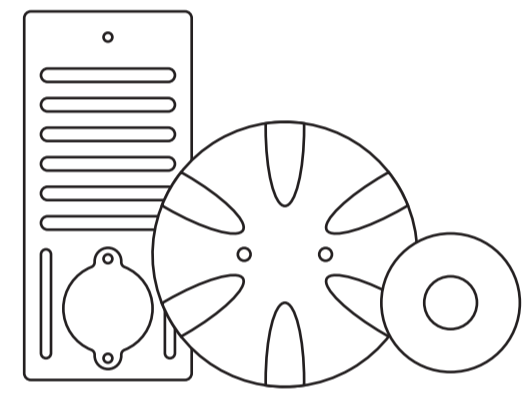

x1 Skimmer,
Suction & Return

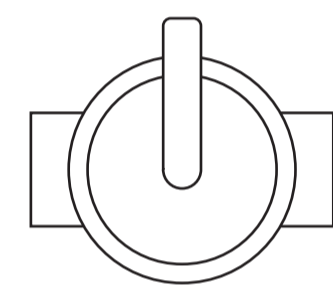

x2 50mm
2-Way Valves

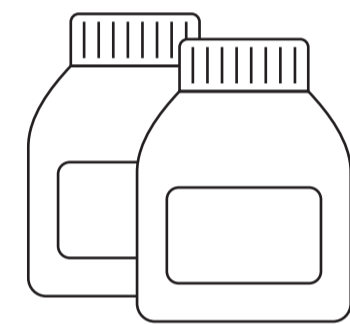

Primer &
Pressure Glue

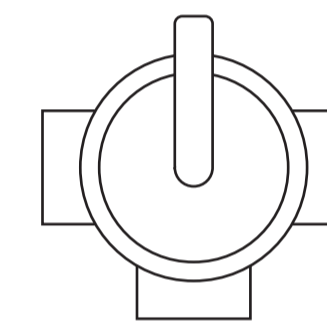

x1 50mm
3-Way Valve

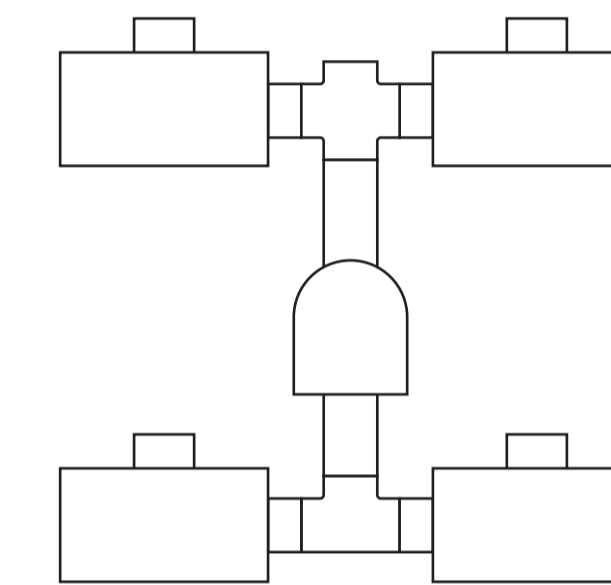

x1 or 2
Spa Jet Manifolds

Customer or Engaged Contractor Provides



40mm & 50mm
Pressure Pipe
(Class 9 or 12)

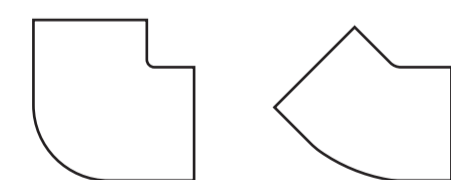

Various 40mm and 50mm
45 & 90 Degree Elbows
(Class 9 or 12)

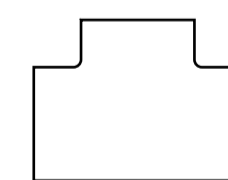

x2 50mm T Coupling
(Class 9 or 12)

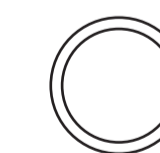

x5 50/40mm
Reducing Bushes

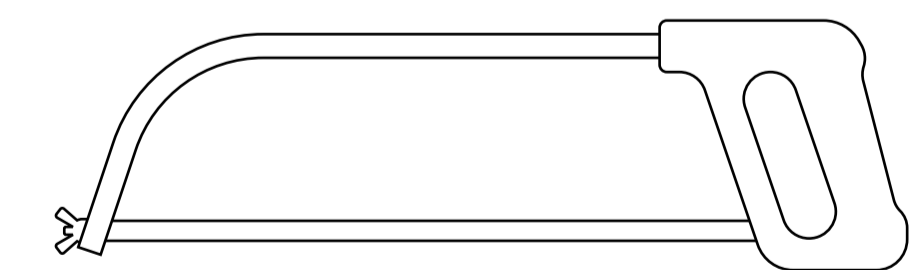

Hacksaw or similar

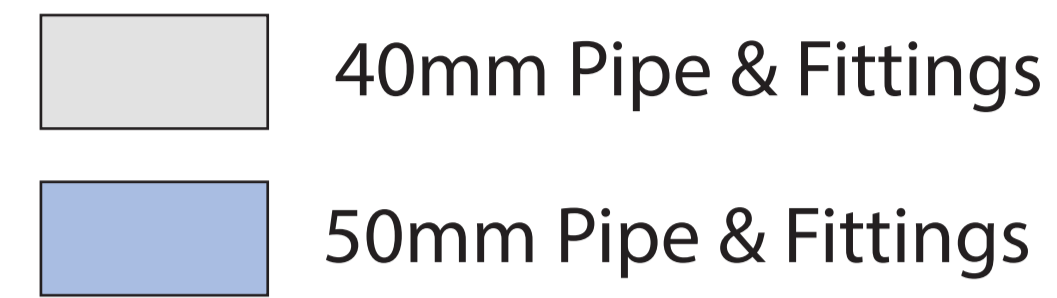

Pool

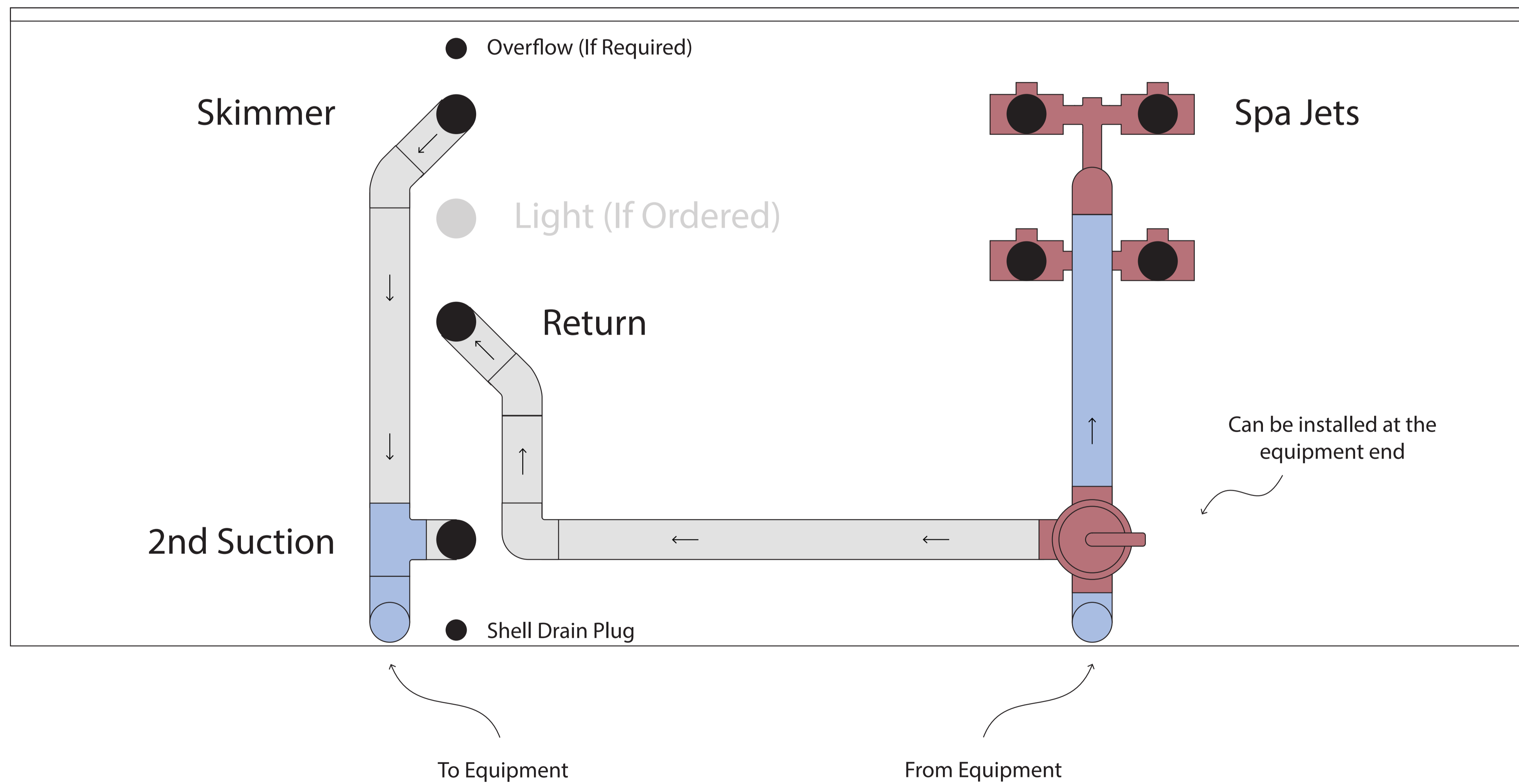

FRONT VIEW (with Single Jets)

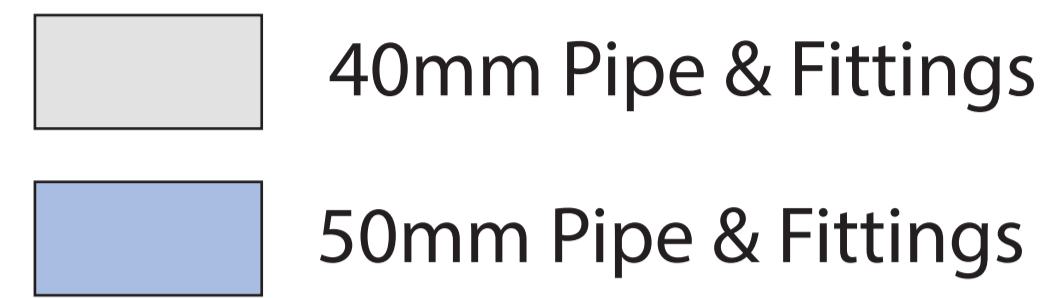

Pool

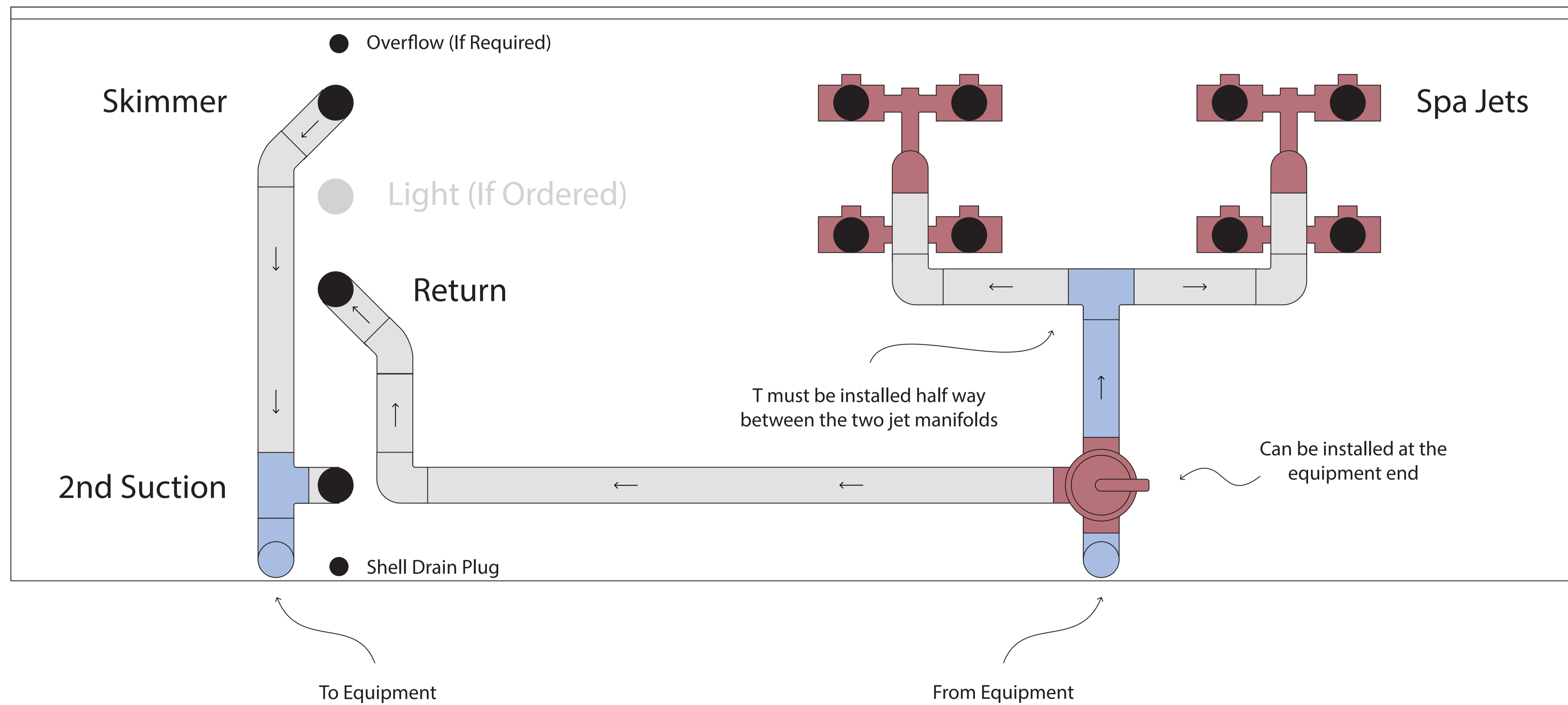

FRONT VIEW (with Double Jets)

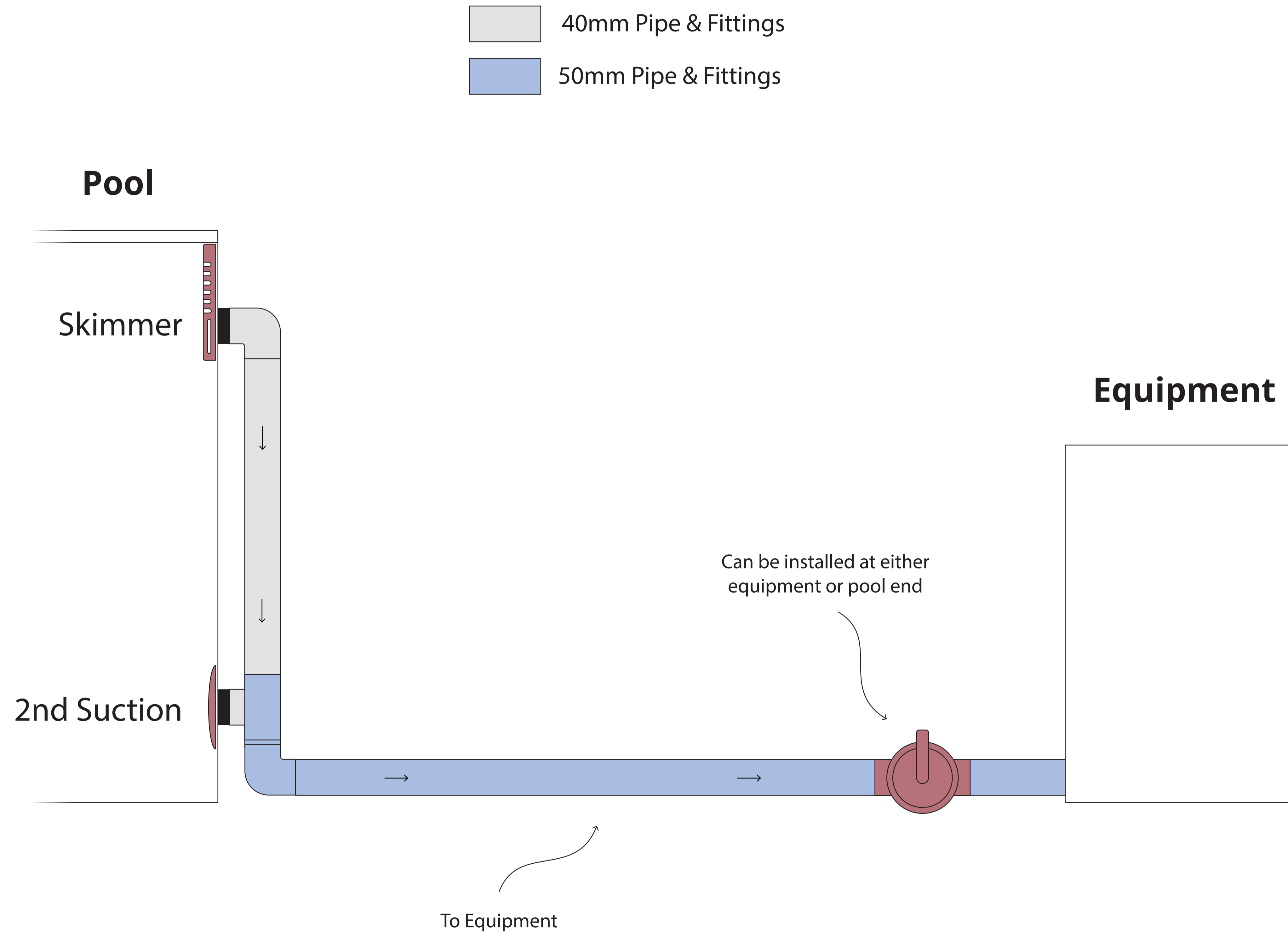

SIDE VIEW (Suctions)

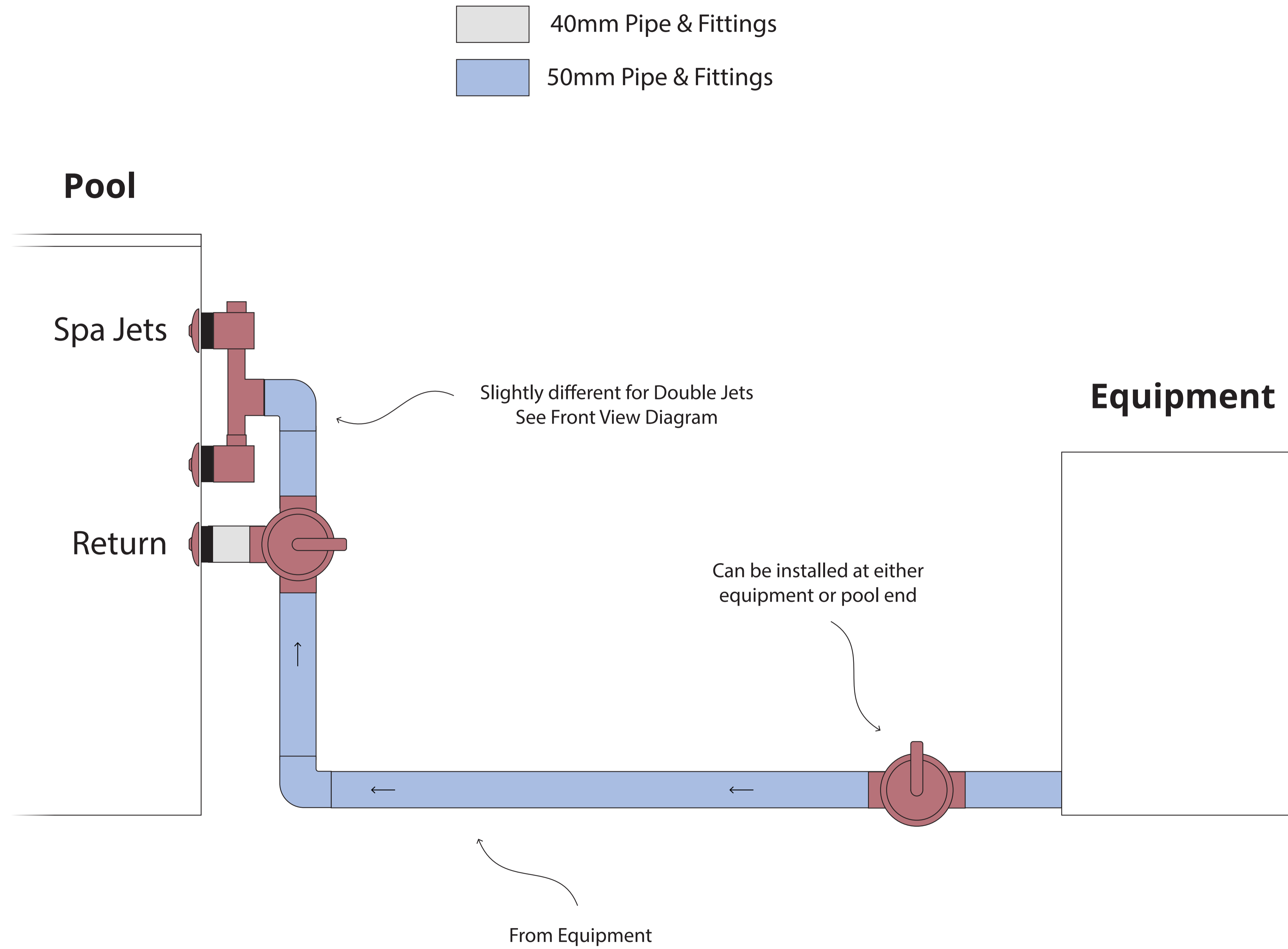

SIDE VIEW (Return)

OUTBACK[®]

PLUNGE POOL

Further Questions

outback.com.au/resources

support@outback.com.au

1300 550 655